

IO-Link makes communication down to the sensor level visible

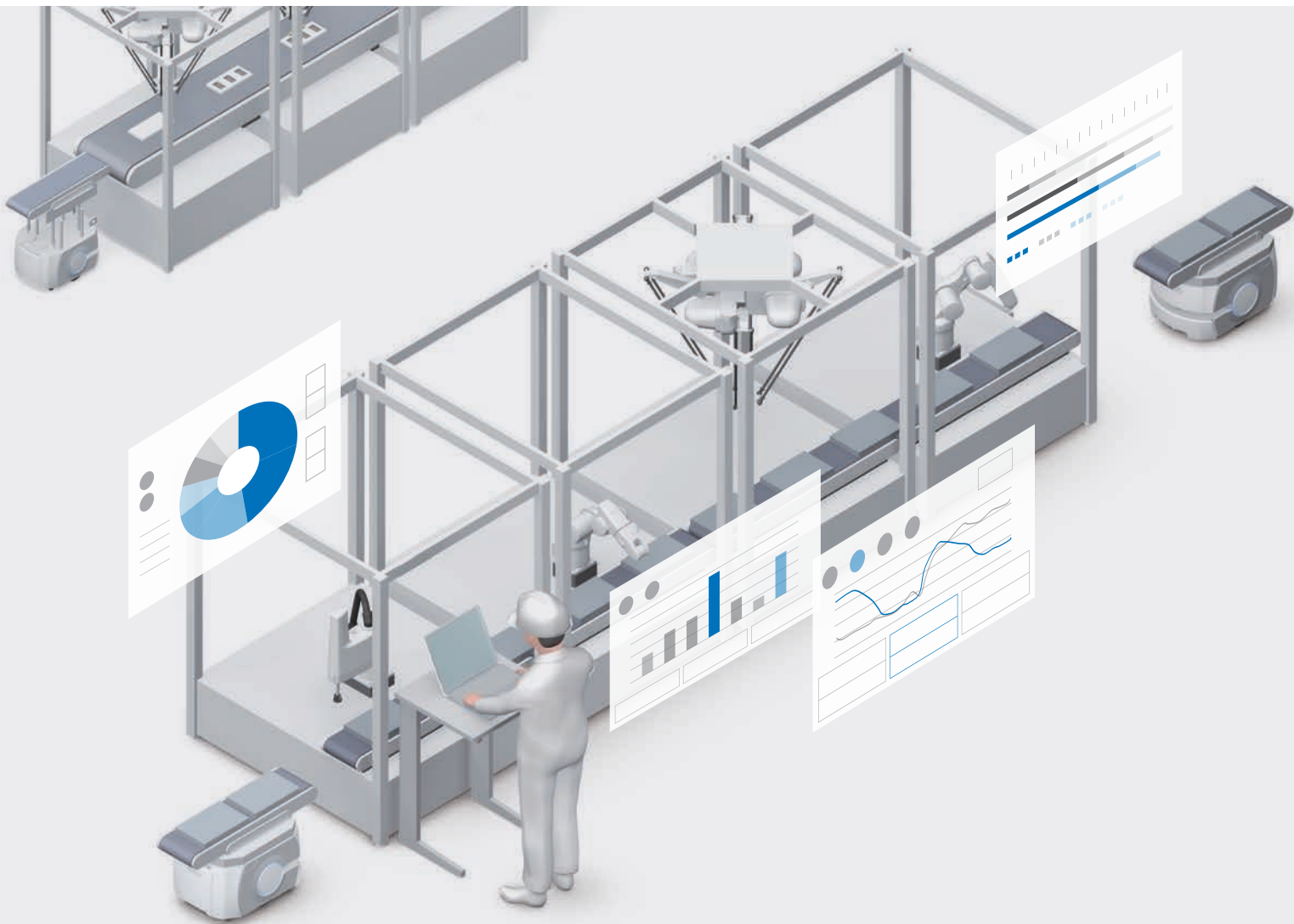

Digitalize manufacturing sites to realize Onsite IoT

The manufacturing industry is under pressure to meet the demands of flexible production and advanced manufacturing. Manufacturers are now approaching future manufacturing innovation by easily and reliably collecting a wide range of data from the production floor and leveraging digital technologies, such as ICT and analysis technology. 'Onsite IoT' uses production floor data to help minimize machine downtime and backtracking and increase machine operation stability and productivity. Offering a wide variety of components including sensors and controllers and further expanding the IoT product lineup to collect onsite data, OMRON can totally help you bring IoT innovation to your manufacturing sites.

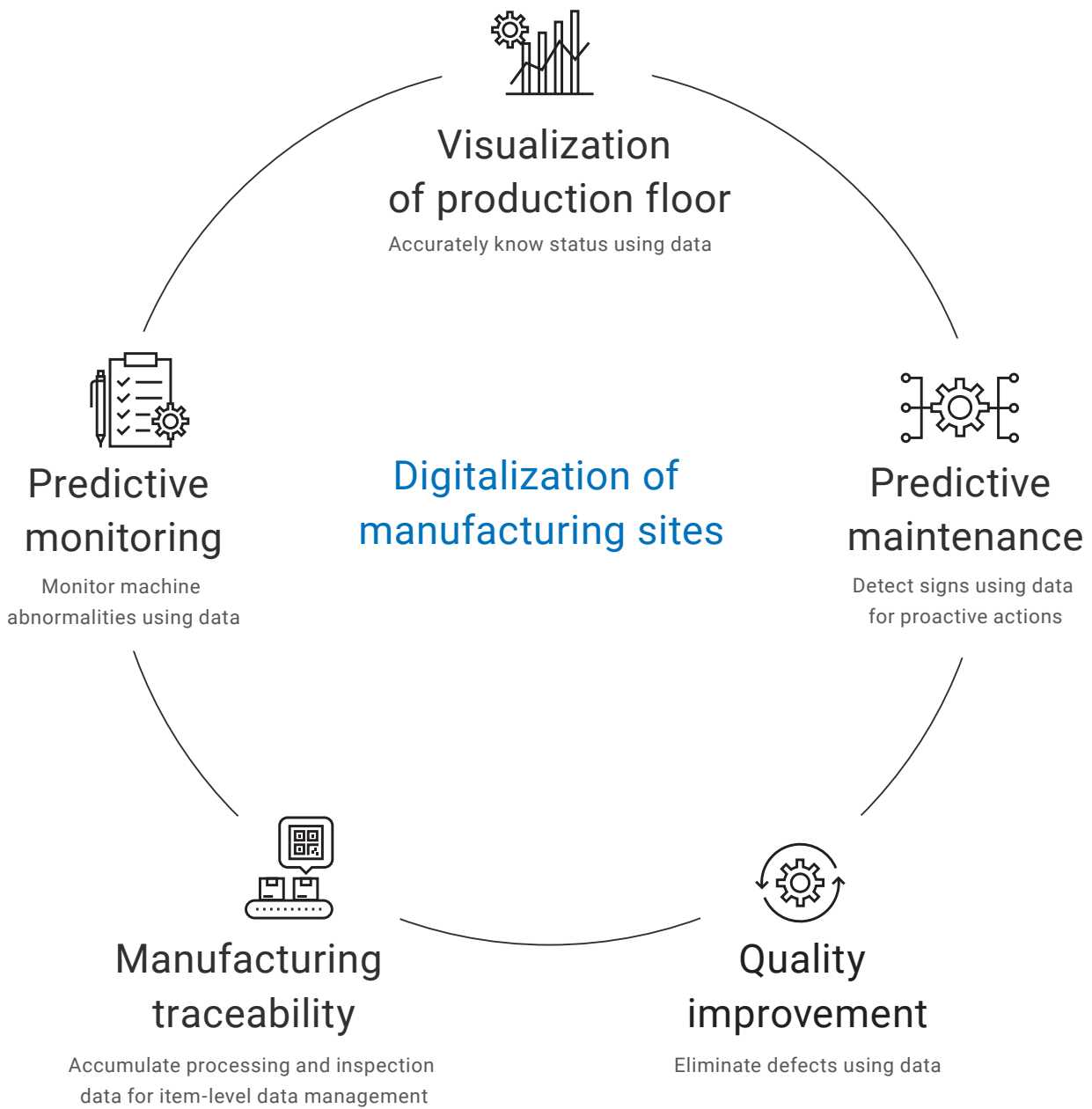

Onsite IoT brings innovation to manufacturing

Real-time onsite data collection, analysis, and utilization

The controller collects data from the manufacturing site (e.g., status monitoring data, production data, and inspection data) in real time while controlling devices. Collected data is accumulated, analyzed, and utilized for various applications such as predictive monitoring of machines, manufacturing traceability, predictive maintenance, and quality improvement.

Onsite data is stored in database connected directly to controller in real time

Database



Data is collected from devices on standard network in real time



Data analysis results are used for control

Data is collected from devices

 **IO-Link**



Digitalize your machine with IO-Link

Replace I/O units with IO-Link masters and install IO-Link sensors and actuators to introduce IO-Link into your production system. In order to bring IoT to a factory, data is collected from various components installed on the production floor via standard networks including IO-Link.

Easy way to adopt IoT at manufacturing sites

Use IO-Link at area level to manage data for important processes.

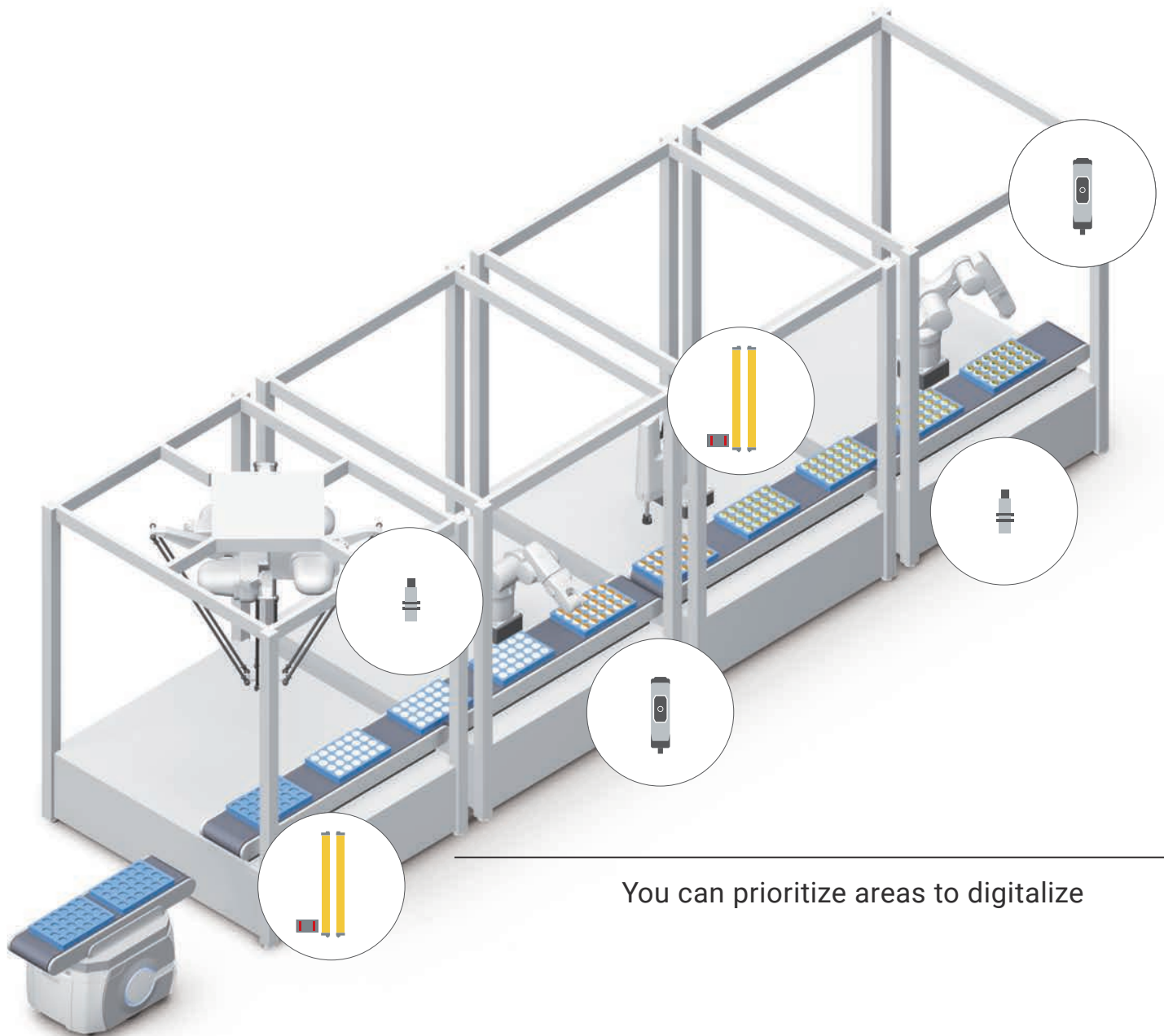

You can prioritize areas to digitalize

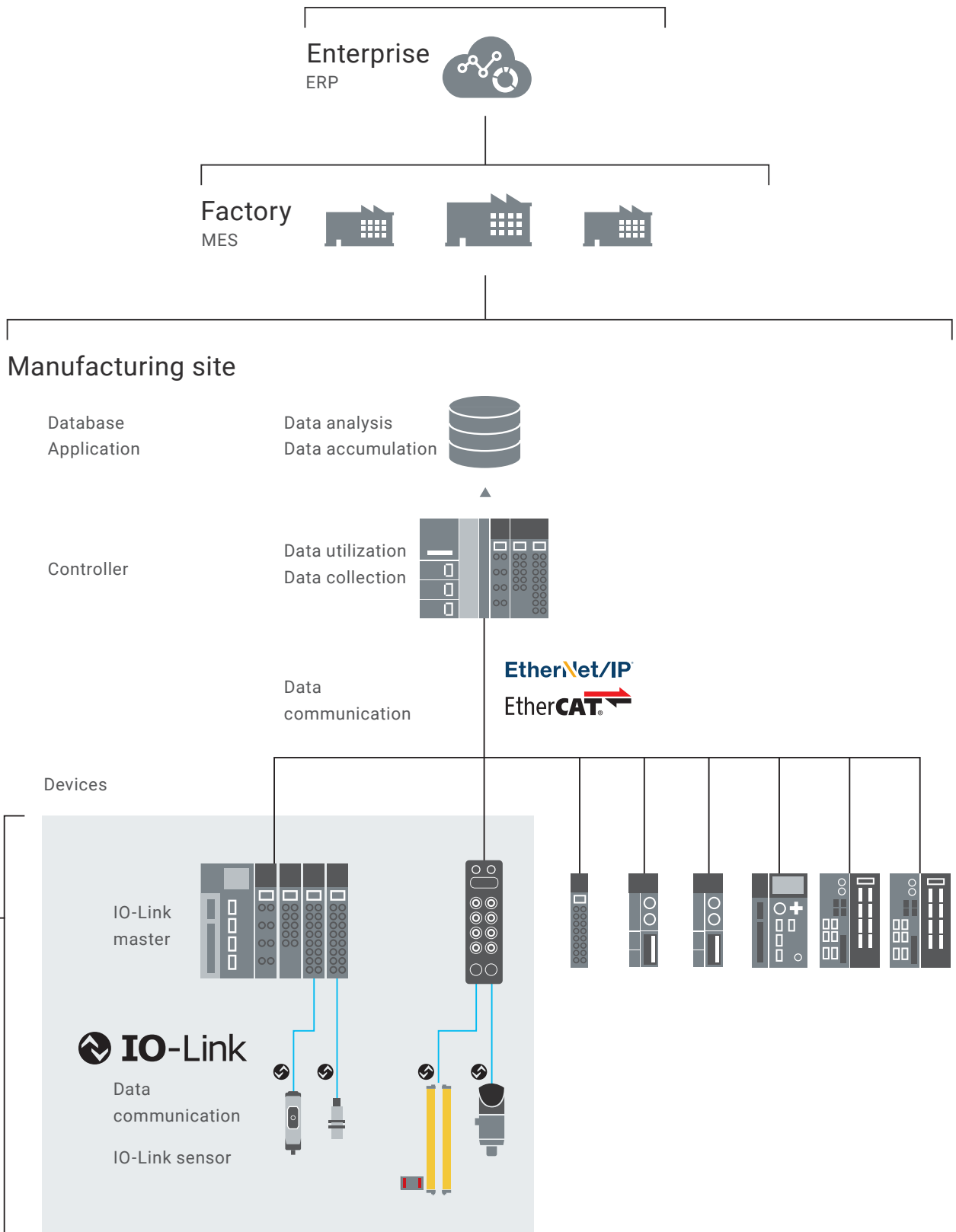

OMRON makes it easy to introduce IO-Link components

OMRON's wide range of IoT products, from sensors to controllers, allows flexible system configuration and easy IoT system design, commissioning, and maintenance. As a PLC manufacturer, OMRON also offers various IO-Link masters and components with useful features, facilitating introduction of an IO-Link system.

Flexible system configuration

You can connect IO-Link sensors and actuators in many different ways to suit your application. The IO-Link master can also be connected to standard sensors. This means you can use IO-Link sensors in your existing system.

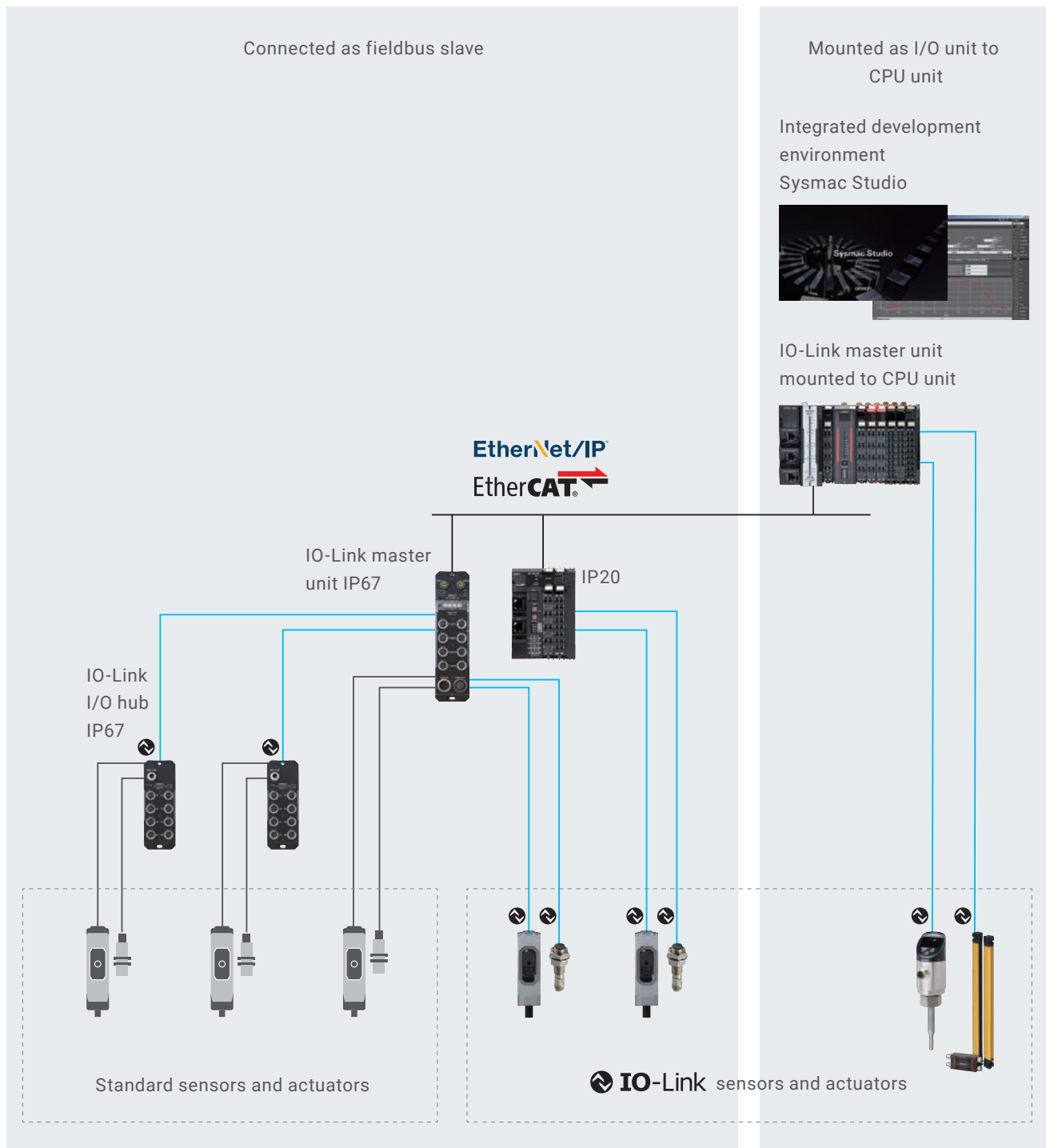

Speed up design, commissioning, and maintenance

The intuitive operation simplifies configuration and programming, and the configuration software (integrated development environment Sysmac Studio) provides many useful functions. This reduces setup and commissioning time of IO-Link systems.

Reduce configuration time with automatic parameter setting and automatic device variable generation

Just select and place a device on the Sysmac Studio to automatically set all parameters at once and automatically generate device variables on the I/O map. It is possible to reduce configuration time and minimize configuration mistakes.

Select and place an IO-Link device just by dragging and dropping it on the Sysmac Studio

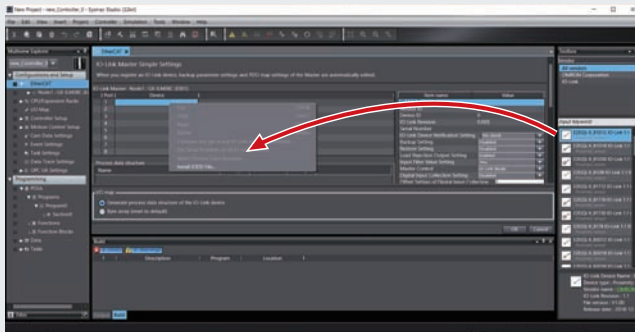

No need to enter related setting parameters
Automatic update

No need to program
Automatic generation of device variables according to process data



Minimize commissioning and replacement time

Setting all devices from the controller significantly reduces setup time.

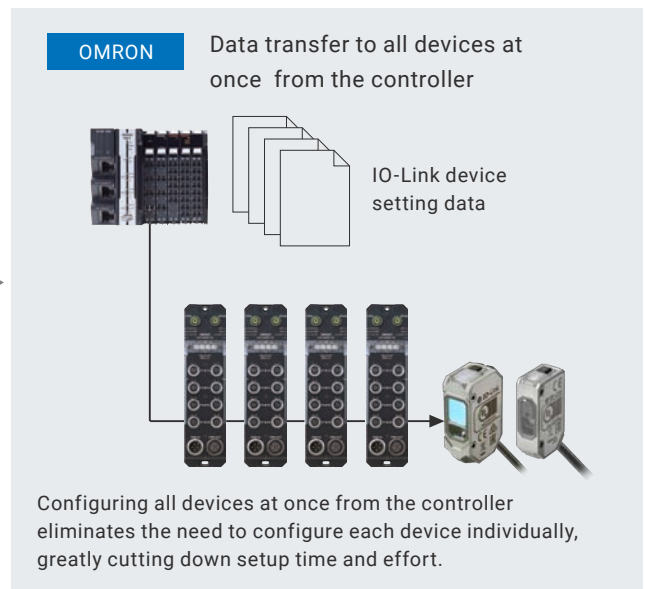
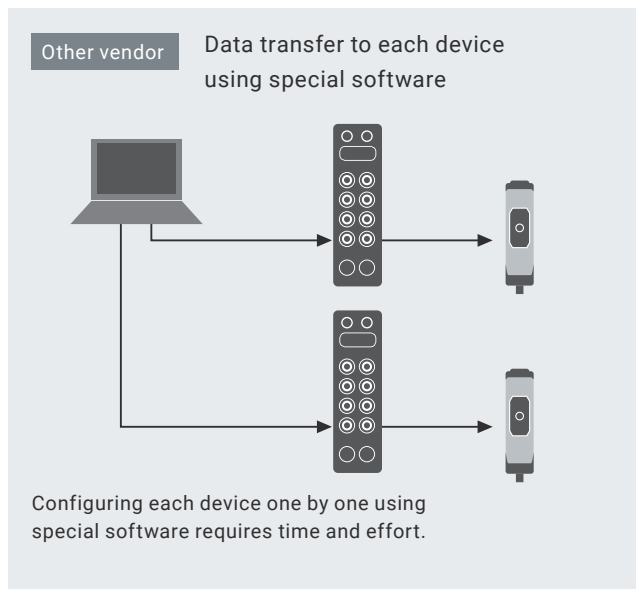

IO-Link: a communication technology reaching the sensors level

IO-Link, specified as international standard IEC 61131-9, is an open information technology (interface technology) between the sensor or actuator and the I/O terminal. It collects information from the sensor or actuator, which allows you to accurately monitor the status of the manufacturing site. IO-Link enables communication within the whole system and reduces time required for commissioning and maintenance.

An open international standard

As of November 2019, over 260 companies, including major sensor manufacturers, have joined the IO-Link Consortium. A system can be built with devices from OMRON and other vendors.

For the latest information, visit <https://io-link.com/en/>

Third party compatibility

All IO-Link sensors have an IODD (Input Output Data Description) file that lists the component type and what parameters need to be set. IODD files are a global standard, so IO-Link components can be used interchangeably with any IO-Link manufacturer.

Information beyond ON and OFF

IO-Link sends and receives not only ON/OFF signals, but also sensor information.

Three baud rates (COM1: 4.8 kbps, COM2: 38.4 kbps, COM3: 230.4 kbps) are possible in IO-Link specifications. OMRON's IO-Link components are compatible with COM2 and COM3, and are capable of high speed communications.

Status monitoring and batch setting

The IO-Link master has multiple ports, and an IO-Link sensor is connected to each port. Unlike a fieldbus network, communication is point-to-point.

Simple wiring with standard cables and connectors

No special communication cables are needed. The same pin is used for both standard input/output and IO-Link communication. Standardized M5, M8, and M12 connectors are used.

Standard 3-wire unshielded cable and connector

IO-Link works with a conventional 3-wire unshielded cable - no dedicated communication cable is required. IO-Link has both an IO-Link Mode which communicates digitally and Standard I/O (SIO) Mode which uses conventional contact input/output.

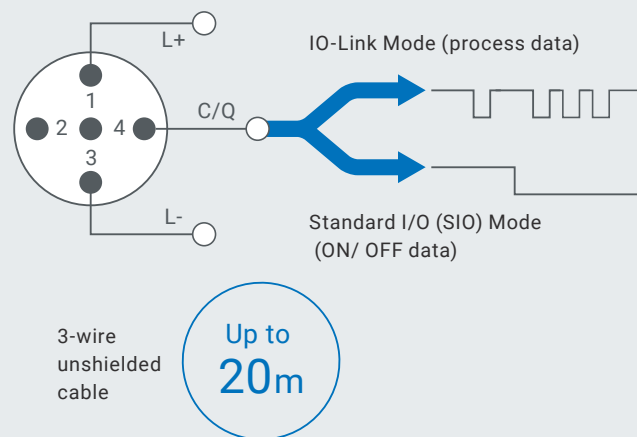

Mix of IO-Link and standard sensors

You can have standard and IO-Link sensors and actuators on the same IO-Link master.

Add IO-Link to existing system

You can add IO-Link sensors to existing trouble spots where additional data or troubleshooting is required.

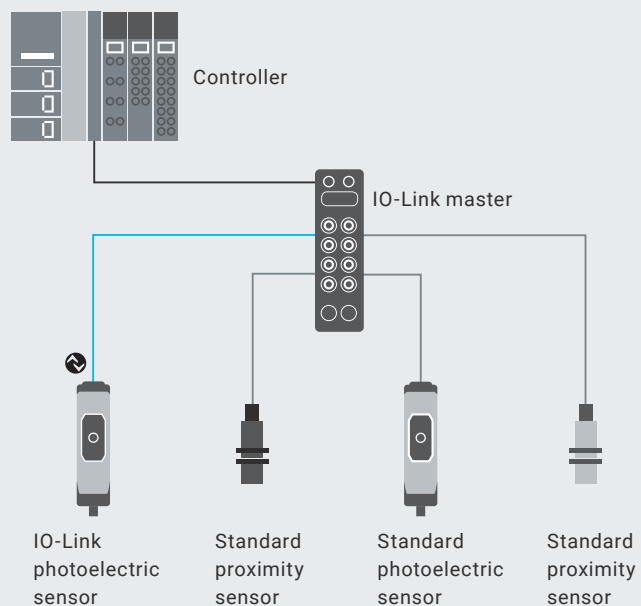

Maximize machine uptime by minimizing Availability Loss and Quality Loss

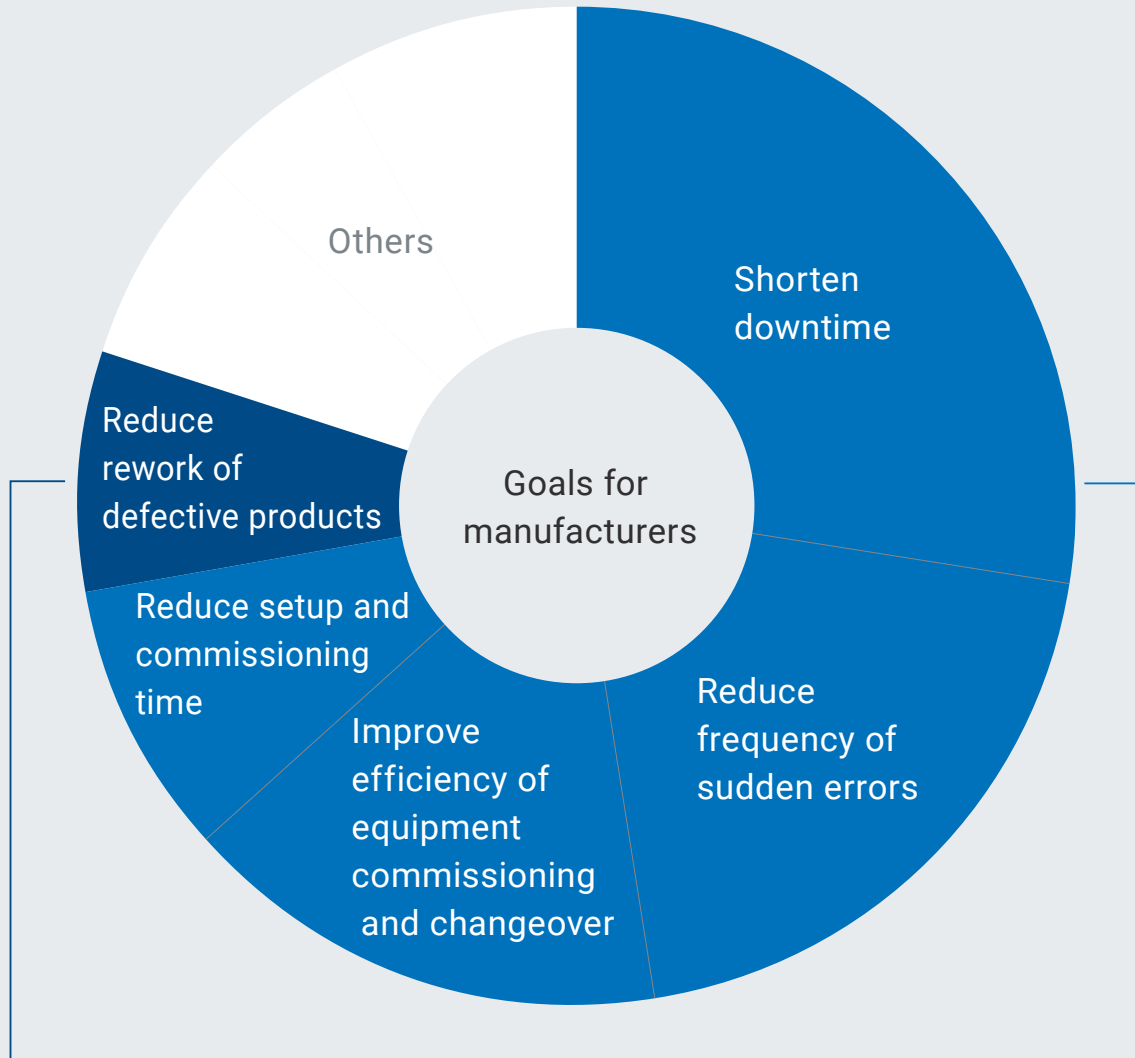

Quality Loss



Consistent product

Accuracy improvement

Availability Loss

Breakdowns



Predictive monitoring

Quick recovery

Setup/adjustments



Design time reduction

Commissioning time reduction

Maintenance time reduction

* Based on OMRON's analysis results.

OMRON's IO-Link Predicts, Improves, and Simplifies to address manufacturing issues

Predict

Condition monitoring and fault detection avoid breakdowns

Condition monitoring of machines reduces unplanned machine stops. Real-time data collection from sensors helps minimize downtime.

Improve

Improved accuracy reduces Quality Loss

Signs of failure can be identified, preventing defective products from being produced. High-accuracy control further increases production quality.

Simplify

Simple operation speeds up setup

OMRON's IO-Link system including IO-Link masters, sensors, and software facilitates design and commissioning, which helps accelerate improvement across the manufacturing site.



Applications for various steps

Smart production lines using IO-Link improve all steps, from design and commissioning through to operation and maintenance, increasing operating efficiency and quality.

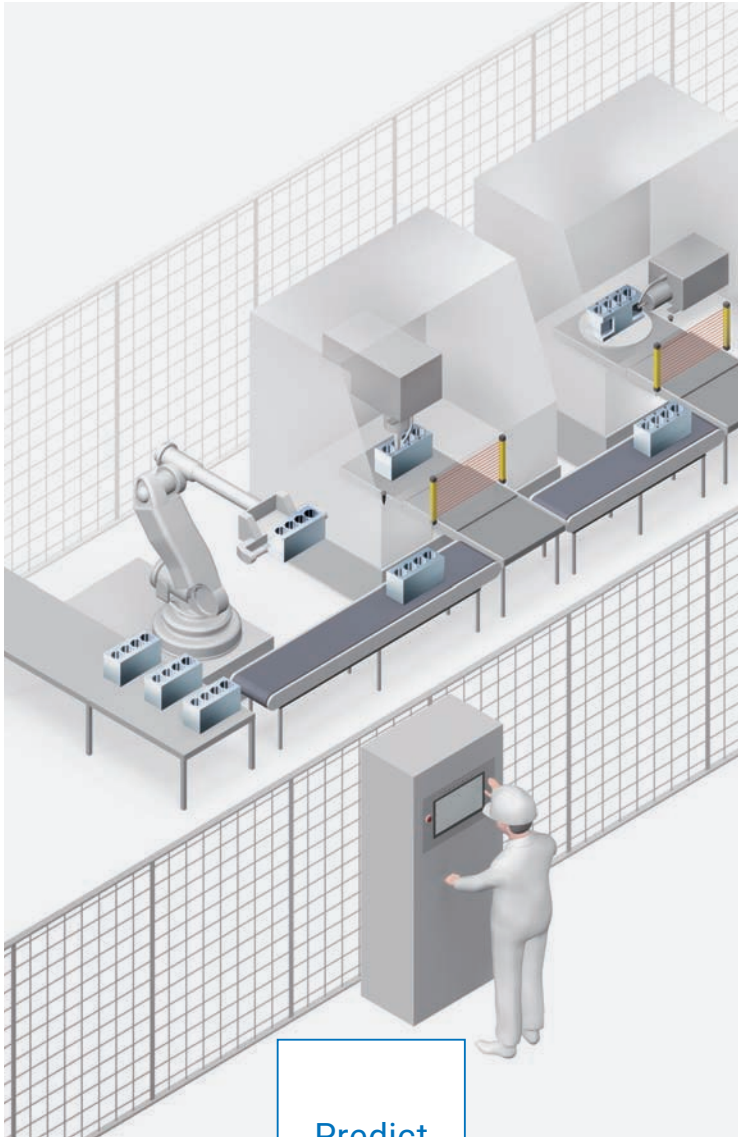

Predict

Predictive monitoring and quick recovery boost uptime

► Page 14

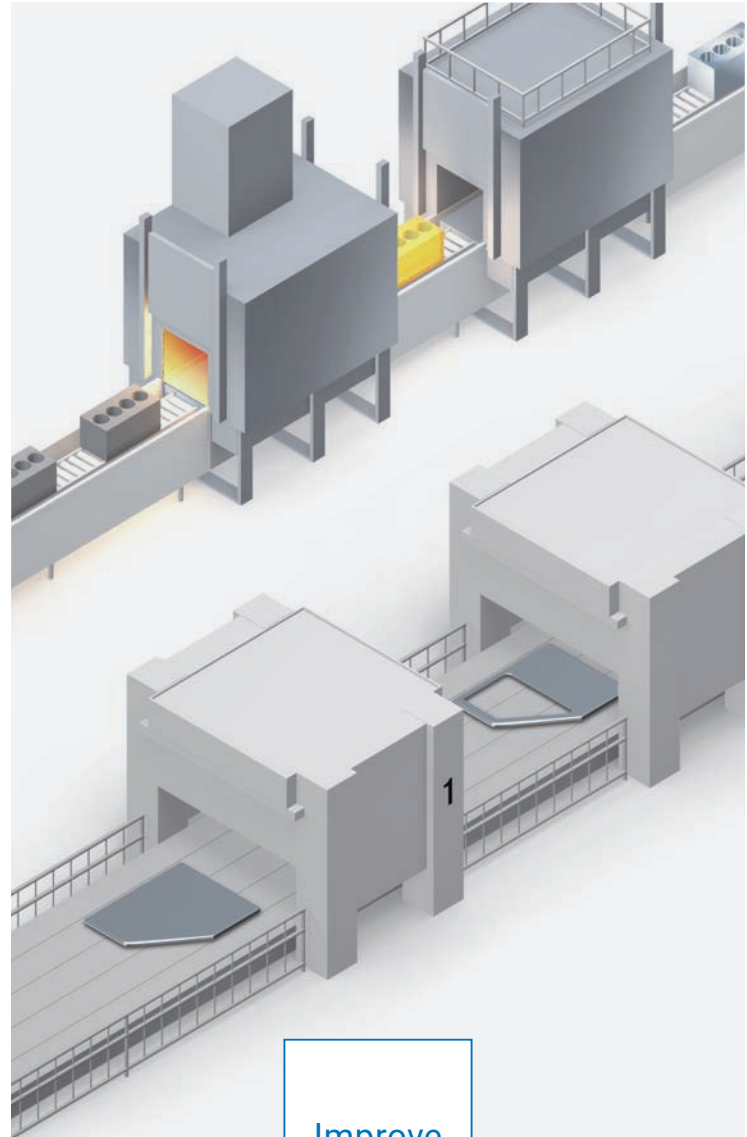

Improve

Visualization of various data improves manufacturing quality

► Page 16

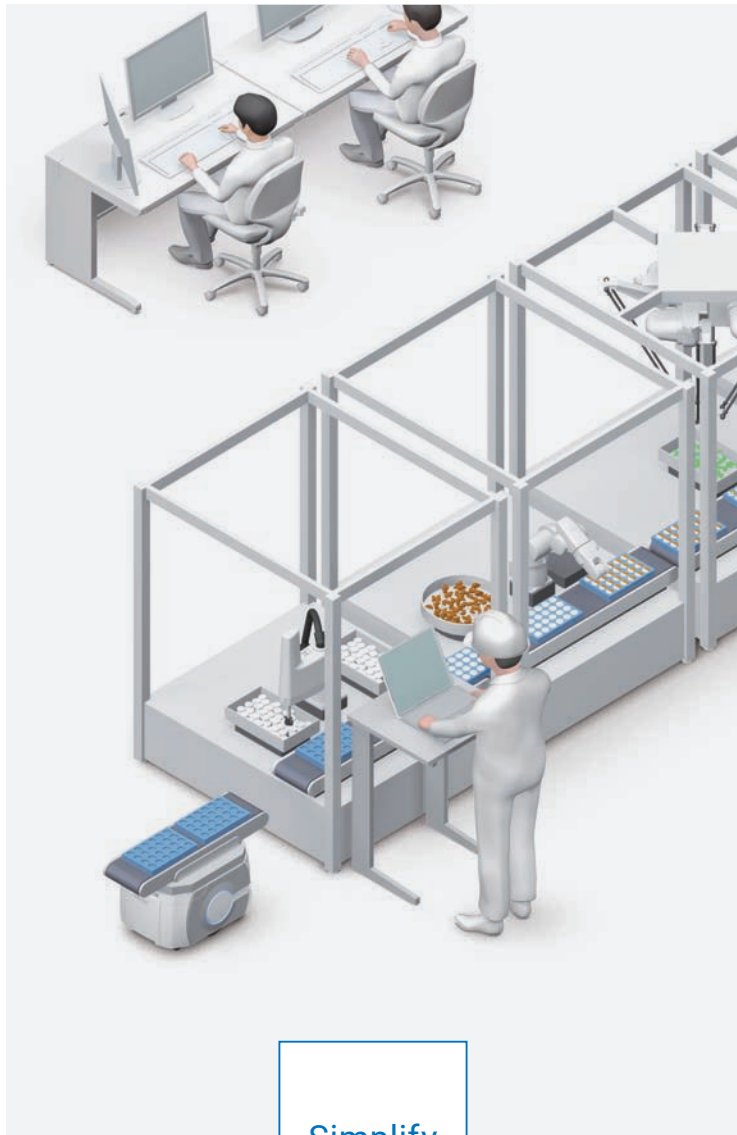

Simplify

Reduce design time

► Page 18

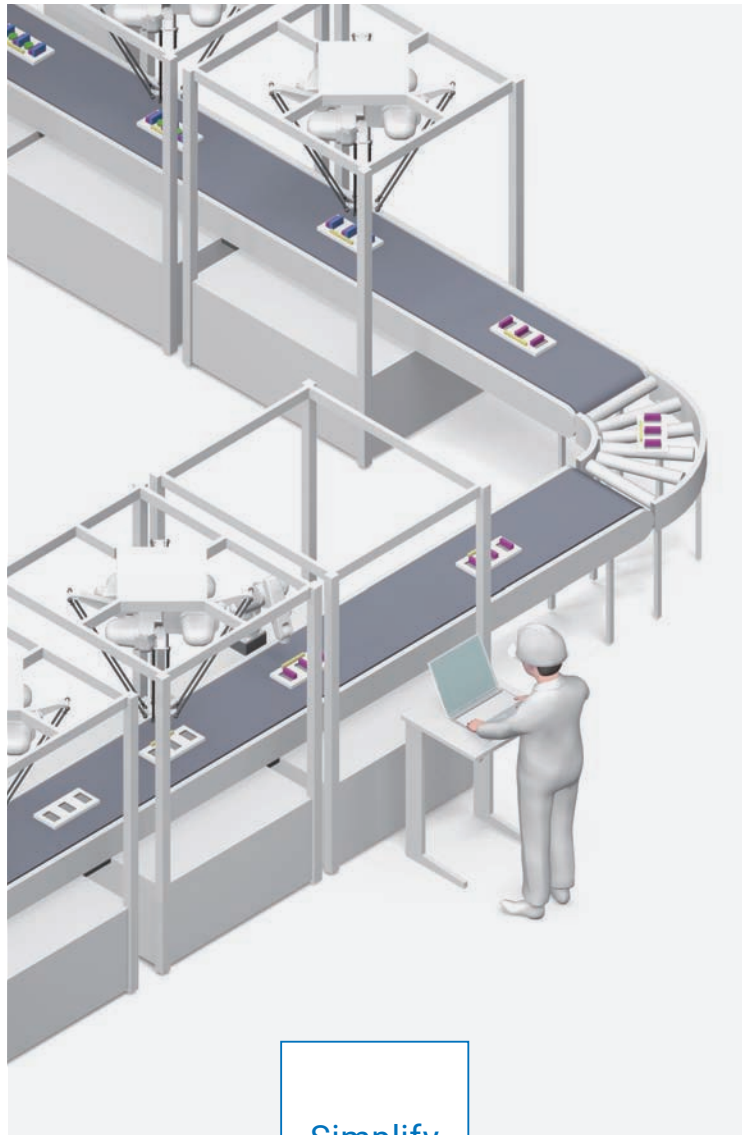

Simplify

Reduce commissioning and maintenance time

► Page 20

Predict

Predictive monitoring and quick recovery boost uptime

Machine condition monitoring using data collected from various devices allows you to take proactive actions, reducing unplanned stops. When an error is detected, detailed information is provided promptly. This helps minimize downtime.

Problem

The location of the target object changes over time due to deterioration of the mechanism, resulting in sudden stops.

Problem



Dirt on the sensing surface blocks sensor beam, resulting in sudden stops.

Problem

When the machine stops, it is difficult to identify the cause.

Provides early warning if the target distance is changing, preventing a problem from occurring

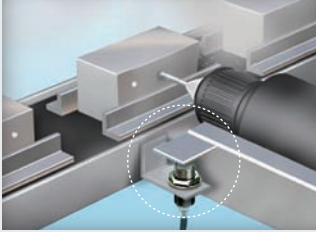
Solve a problem before the machine stops.

Detection Level



Constantly monitoring the position of the target object and reporting excessive remoteness or proximity are useful for predictive maintenance.



Proximity sensor

Provides early warning if the light intensity drops, preventing false detection

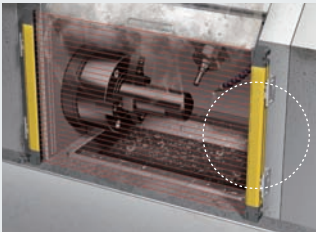
Solve a problem before the machine stops.

Incident Light Level

Light intensity drop due to dirt accumulated on the light curtain is reported. You can do predictive maintenance by taking action before false detection occurs.



Light curtain, photoelectric sensor

Reports fault location and condition, minimizing downtime

Quickly restore the machine even if it stops.

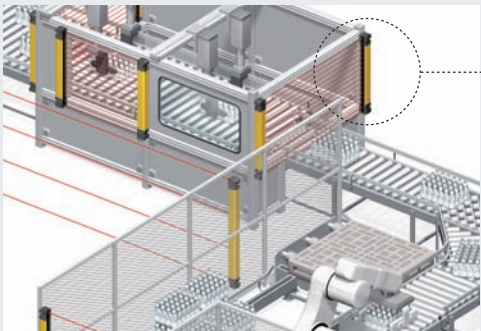
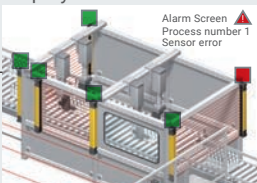

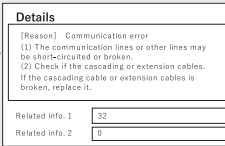

Display of error location



Display of detail error information

When a fault occurs, IO-Link allows you to see which sensor faulted and the possible cause of the error. With this information, you can determine the required action and quickly bring the equipment back online.



Light curtain, photoelectric sensor, proximity sensor, flow sensor

Improve

Visualization of various data improves manufacturing quality

A variety of quality-related data can be visualized. Signs of failure can be identified to take proactive action before failure affects quality, reducing Quality Loss.

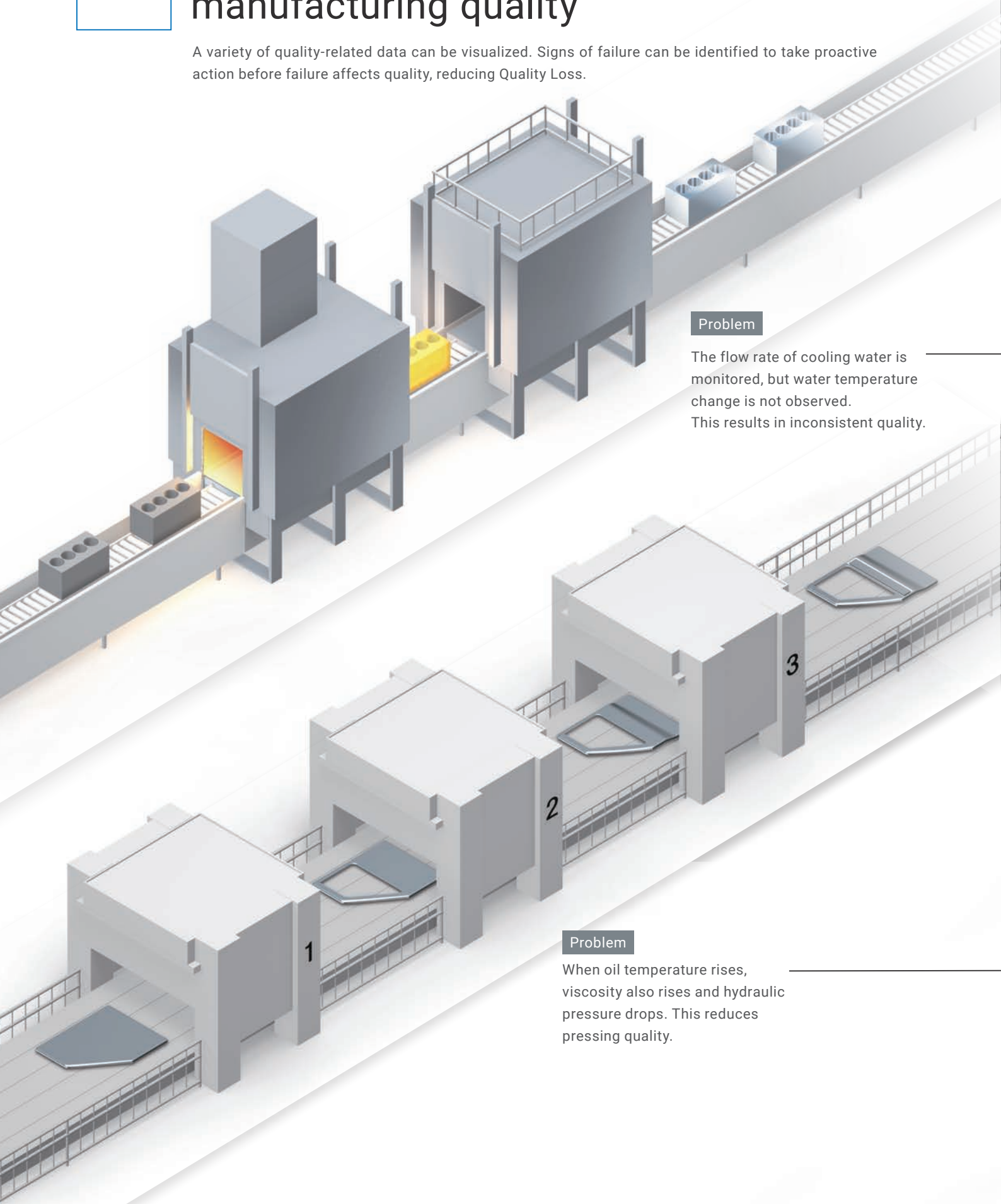

Problem

The flow rate of cooling water is monitored, but water temperature change is not observed. This results in inconsistent quality.

Problem

When oil temperature rises, viscosity also rises and hydraulic pressure drops. This reduces pressing quality.

Monitors multiple sets of process data to ensure strength of parts

Increase accuracy by monitoring multiple sets of data.

[Example of carburizing furnace]

The flow rate and temperature of cooling water are monitored to maintain cooling quality.

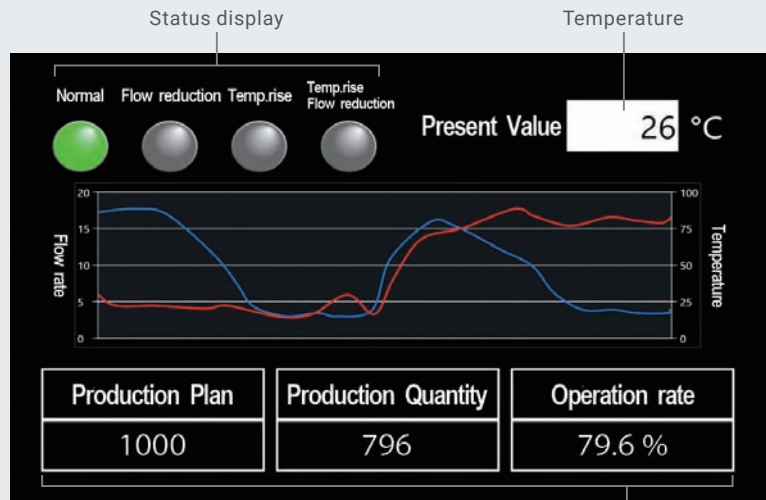
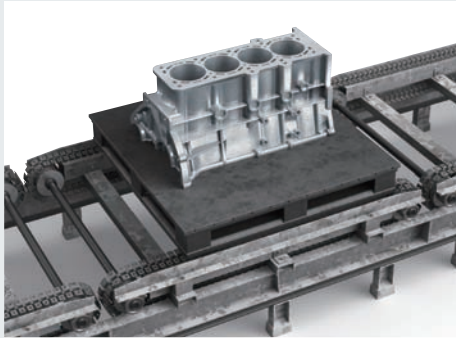

— Flow rate — Temperature Actual production

Simultaneously monitoring the flow rate and temperature of cooling water enables cooling to be maintained and controlled. This ensures a consistent finish and raises the standard of parts strength.

IoT flow sensor



Monitors multiple sets of process data to allow adjustment of processing conditions before a defect occurs

Maintain quality by monitoring multiple sets of data.

[Example of pressing machine]

The pressure and temperature of oil are monitored to maintain pressing quality.

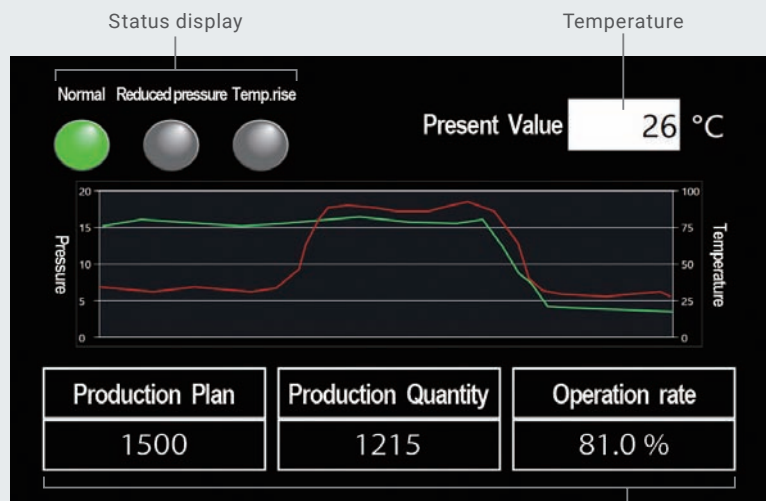

— Pressure — Temperature Actual production

Simultaneously monitoring the pressure and temperature of oil enables pressing conditions to be maintained and controlled. This ensures a consistent finish and raises the standard of pressing quality.

IoT pressure sensor



Simplify

Reduce design time

Save setup time through intuitive operation without reading manuals and through automatic generation of variables.



Problem

Engineers have to make many settings while reading manuals.

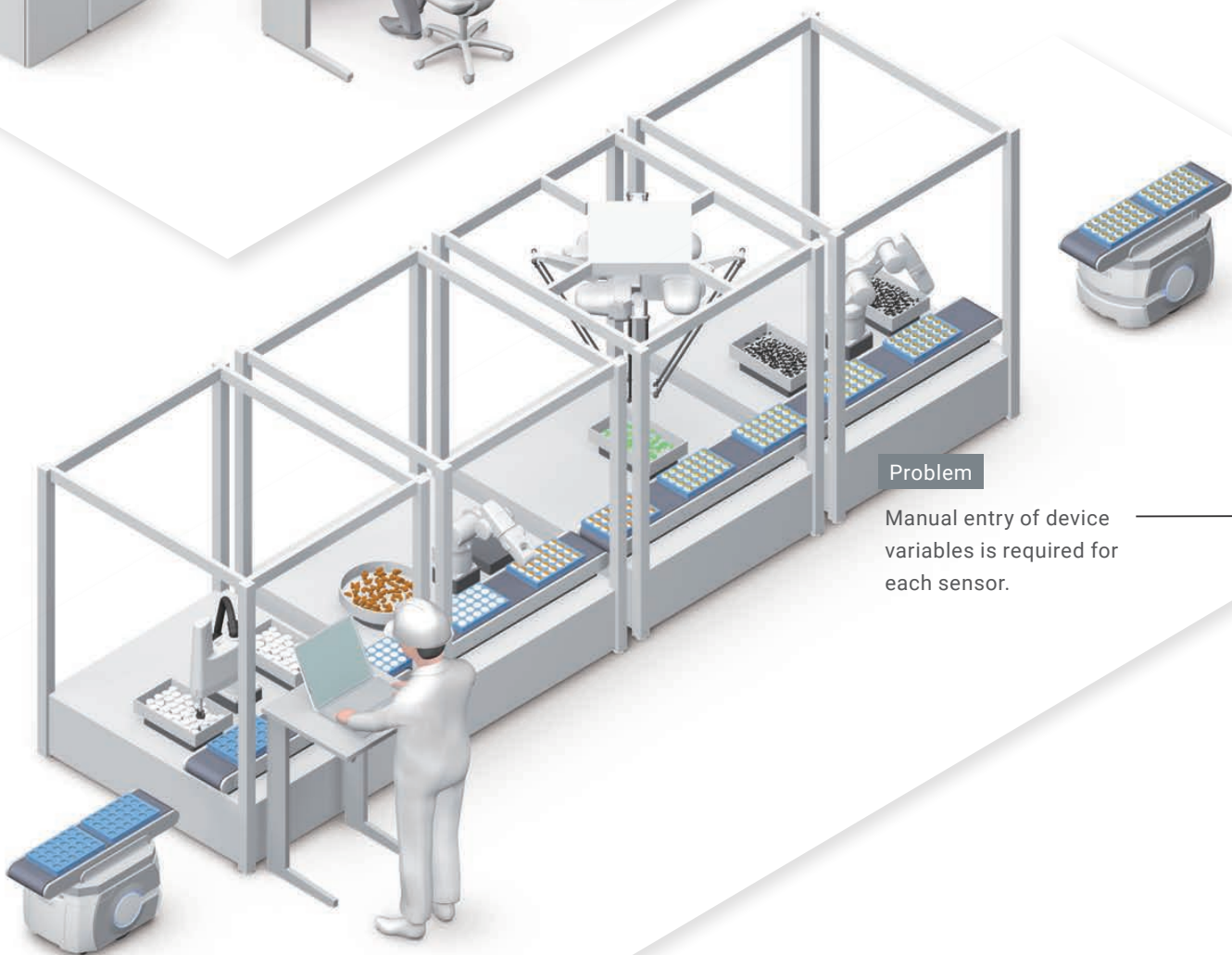

Problem

Manual entry of device variables is required for each sensor.

Problem

IO-Link has to be configured manually after wiring.

Just drag and drop devices to configure all necessary devices at once*1

Set parameters with simple operation.

Patent pending

World's first *2

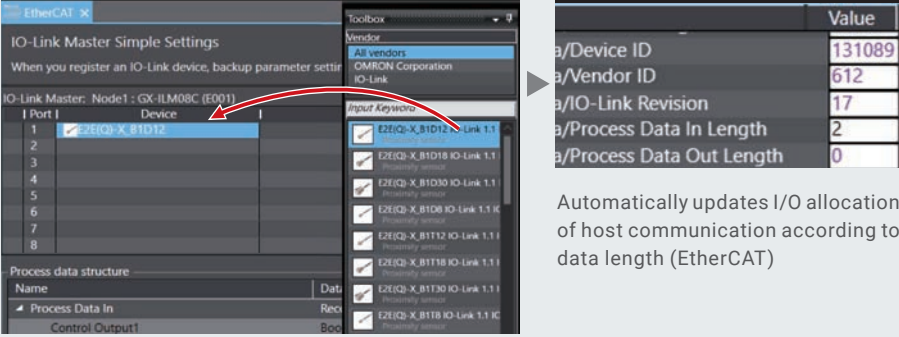

The screenshot shows the 'IO-Link Master Simple Settings' window. On the left, a table lists ports 1-8 and their corresponding devices. A red arrow points from the 'Device' column to the 'Input Keywords' list on the right. To the right of the main window is a parameter table:

Parameter	Value
Device ID	131089
Vendor ID	612
IO-Link Revision	17
Process Data In Length	2
Process Data Out Length	0

Below the table, text reads: 'Automatically updates I/O allocation of host communication according to data length (EtherCAT)'. A small Sysmac Studio logo is in the bottom right corner.

You can configure all devices to use just by dragging and dropping them. This prevents human errors.

Use required data easily*1

Configure IO-Link devices without time-consuming programming.

Patented

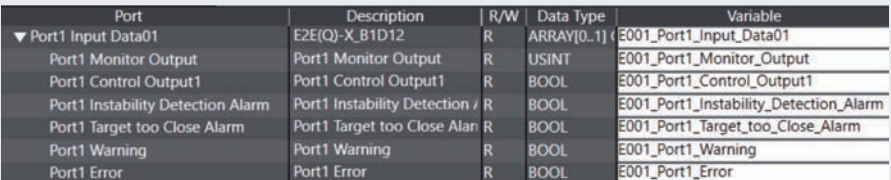

The screenshot shows a table of I/O port variables:

Port	Description	R/W	Data Type	Variable
Port1 Input Data01	E2E(Q)-X_B1D12	R	ARRAY[0..1]	E001_Port1_Input_Data01
Port1 Monitor Output	Port1 Monitor Output	R	USINT	E001_Port1_Monitor_Output
Port1 Control Output1	Port1 Control Output1	R	BOOL	E001_Port1_Control_Output1
Port1 Instability Detection Alarm	Port1 Instability Detection	R	BOOL	E001_Port1_Instability_Detection_Alarm
Port1 Target too Close Alarm	Port1 Target too Close Alarm	R	BOOL	E001_Port1_Target_too_Close_Alarm
Port1 Warning	Port1 Warning	R	BOOL	E001_Port1_Warning
Port1 Error	Port1 Error	R	BOOL	E001_Port1_Error

Text below the table reads: 'I/O port of sensor'. A small Sysmac Studio logo is in the bottom right corner.

Device variables (variable names) are automatically generated on the I/O map according to process data. You can easily use necessary data on the program.

Easily reuse settings by copying and pasting

Make configuration simple and fast.

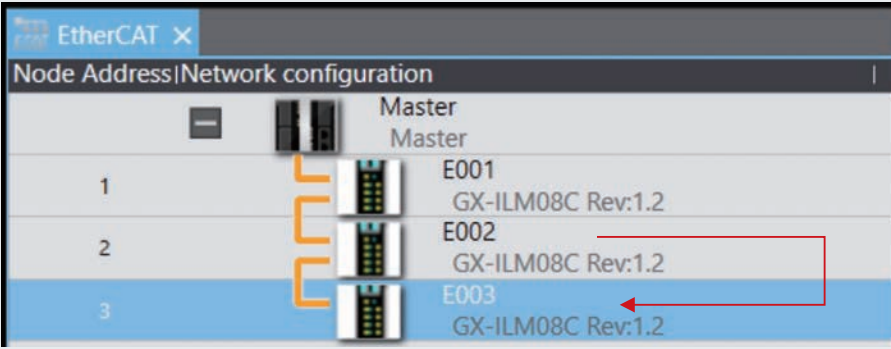

The screenshot shows a list of IO-Link devices in the 'Node Address|Network configuration' window:

Node Address	Network configuration
1	Master Master
1	E001 GX-ILM08C Rev:1.2
2	E002 GX-ILM08C Rev:1.2
3	E003 GX-ILM08C Rev:1.2

A red box highlights the configuration for node 3, and a red arrow points to it from the right. A small Sysmac Studio logo is in the bottom right corner.

IO-Link device information can be copied and pasted from a configuration that has already been set up, making reuse easy.

*1. Available via EtherCAT. *2. Based on OMRON investigation in July 2019.

Simplify

Reduce commissioning and maintenance time

Save setup time through intuitive operation without reading manuals and through automatic generation of variables.

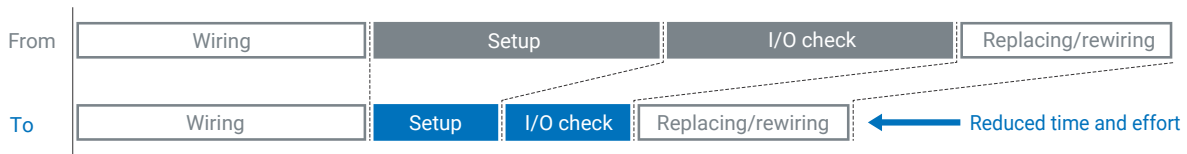

Problem

During commissioning or changeover, operators have to perform I/O check for each of the thousands of sensors installed on the line.

Problem

After commissioning, it takes time to identify installation mistakes.

Problem

System improvement and change require time and effort and can cause mistakes, leading to lower operating efficiency.

Detect installation mistakes before commissioning

Reduce time required for checking.

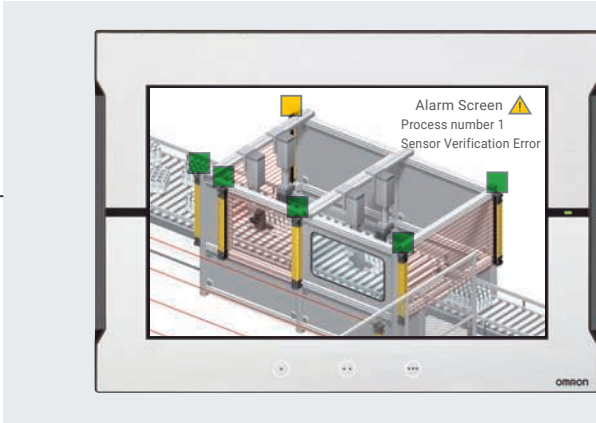

By checking the sensor identification (manufacturer, sensor type, model) on the HMI before commissioning, you can easily detect mistakes such as misconnected or unconnected sensors and installation errors, and can take action immediately. This enables fast commissioning.



Light curtain, photoelectric sensor, proximity sensor, flow sensor

Download all at once from IO-Link device configuration tool

Significantly reduce configuration time.

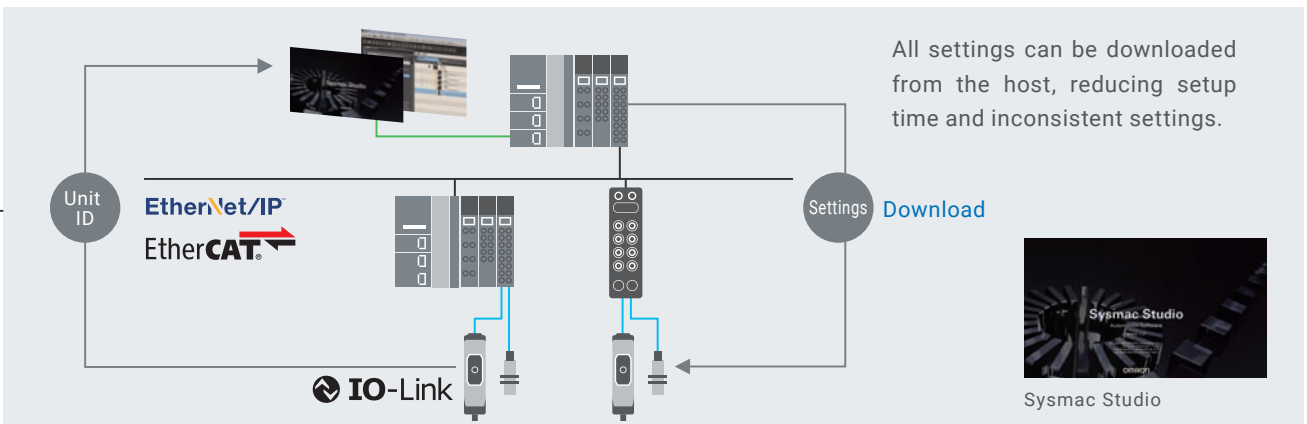

All settings can be downloaded from the host, reducing setup time and inconsistent settings.

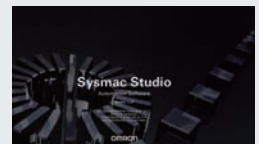

Sysmac Studio

Upload wired device information

Reduce setup time by easily checking the status of installed sensors.

Patented

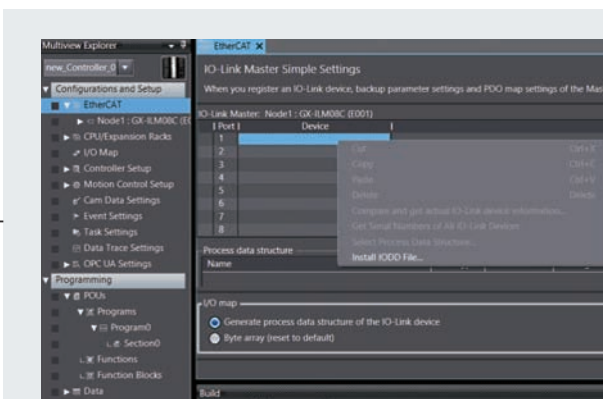

You can set IO-Link device information that can be easily obtained from the physical system configuration. Maintenance is possible even if connected sensor information is unknown.

Compare and Get Actual IO-Link Device Information

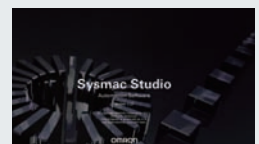

Sysmac Studio

Masters and sensors to match your application

OMRON offers two different types of connection between IO-Link masters and IO-Link sensors: screwless clamping terminal blocks and M12 connectors. The IO-Link masters provide EtherCAT and EtherNet/IP connectivity. You can choose a model to suit your installation environment and system configuration.

IO-Link Masters

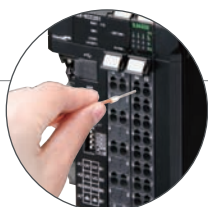

Corresponding to our shared Value Design for Panel concept for the specifications of products



NX-series
IO-Link Master unit

NX-ILM400
4 IO-Link ports

Simple wiring
Screwless clamping terminal block

► Page 39

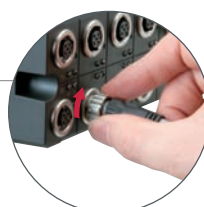

Just plug in and turn 1/8 of a rotation



GX-series
IO-Link Master unit

GX-ILM08C
8 IO-Link ports

IP67 protection
M12 Smartclick connector

► Page 39



NXR
IO-Link Master Unit

EtherNet/IP™
NXR-ILM08C-EIT
EtherCAT®
NXR-ILM08C-ECT **NEW**
8 IO-Link ports

IP67 protection
M12 connector

► Page 38

IO-Link Sensors



Safety Light Curtain
/Safety Multi-Light Beam
F3SG-SR/PG

Easy to monitor and ready for IoT

► Page 36



IoT Flow Sensor
E8FC-25□
Simultaneous measurement of Flow Rate + Temperature

► Page 24



IoT Pressure Sensor
E8PC-□
Simultaneous measurement of Pressure + Temperature

► Page 24



Distance-settable Photoelectric Sensor
E3AS
E3AS Series changes the "way of using" reflective photoelectric sensors

► Page 25

IO-Link I/O Hub



**NXR IO-Link
I/O Hub**

NXR-□D166C-IL2
8 I/O connectors

IP67 protection
M12 connector

► Page 38

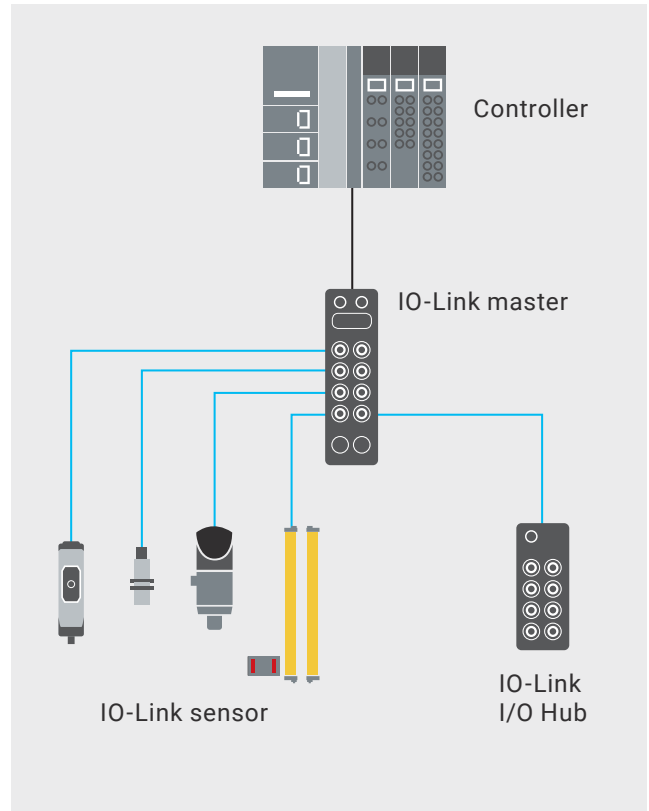

Photoelectric Sensor

E3Z-□-IL□

Standard Photoelectric
Sensor

► Page 26



**Color Mark
Photoelectric Sensor**

E3S-DC□

Color Mark Detection
on Any Type of Packaging

► Page 27



**Full metal body
Proximity Sensor**

E2EW/E2EW-EV

Stable detection in lines
containing both
aluminum and iron

For welding process ► Page 34

For EV battery
manufacturing process ► Page 35



Proximity Sensor

E2E/E2EQ NEXT

Enables easier and
standardized designs
previously not possible

► Page 28

Overview of IO-Link Compliant Devices

IO-Link Sensors

IoT Flow Sensor

E8FC

Detect signs of abnormalities in Cooling Water, Water-Soluble Coolant, and Water-Insoluble oil by simultaneous measurement of “flow rate + temperature”

- Multi-sensing of “Flow rate + temperature” for preventing a sudden stops or manufacturing defects.
- Various lineup of replacement adapters to enable easy replacement of your current pressure gauges and flow meters.
- Analog current output function in addition to the IO-Link communications function that can perform self-diagnosis of abnormalities in the sensor itself.



Applicable fluid	Rated flow rate range (Pipe diameter)	Connection method	IO-Link baud rate	Model
Liquid	0.6 to 14 l/min (10A) 1 to 30 l/min (15A) 1.5 to 60 l/min (20A) 2 to 100 l/min (25A)	M12 Connector (4-pin)	COM2 (38.4kbps) COM3 (230.4kbps)	E8FC-25□□

For details, refer to E8FC/E8PC Series Catalog (No. E472).

IoT Pressure Sensor

E8PC

Detect signs of abnormalities in hydraulic oil and sealant by simultaneous measurement of “pressure + temperature”

- Multi-sensing of “Pressure + temperature” for preventing a sudden stops or manufacturing defects.
- Various lineup of replacement adapters to enable easy replacement of your current pressure gauges and flow meters.
- Analog current output function in addition to the IO-Link communications function that can perform self-diagnosis of abnormalities in the sensor itself.



Applicable fluid *1	Rated pressure range	Connection method	IO-Link baud rate	Model
Liquid and gas	-0.1 to 1 MPa	M12 Connector (4-pin)	COM2 (38.4kbps) COM3 (230.4kbps)	E8PC-010□□(-E)
Liquid	0 to 10 MPa			E8PC-100□□(-E)
	0 to 40 MPa			E8PC-400□□(-E)

*1. The applicable fluid is a liquid that do not erode the liquid contact part materials (such as water, glycol solution, and oil).

For details, refer to E8FC/E8PC Series Catalog (No. E472).

Distance-settable Photoelectric Sensors

E3AS Series

E3AS Series changes the “way of using” reflective photoelectric sensors

- Complete lineup of photoelectric sensors for various applications.
- Teaching method allows anyone to set optimal threshold values.
- Antifouling coating prevents contamination on the sensing surface.
- Ecolab certified in addition to IP67/69K/67G protection.



E3AS-HL models

Line beam type

Red light

Connection method	Sensing distance (white paper)	IO-Link baud rate	Model
Pre-wired (2 m/ 5 m) M12 Pre-wired Smartclick Connector (0.3 m) M8 Connector (4-pin)		COM2 (38.4kbps) COM3 (230.4kbps)	E3AS-HL500LM□(-□) □
			E3AS-HL150LM□(-□) □

Spot type

Connection method	Sensing distance (white paper)	IO-Link baud rate	Model
Pre-wired (2 m/ 5 m) M12 Pre-wired Smartclick Connector (0.3 m) M8 Connector (4-pin)		COM2 (38.4kbps) COM3 (230.4kbps)	E3AS-HL500M□(-□) □
			E3AS-HL150M□(-□) □

For details, refer to E3AS Series Catalog for the automotive industry (No. E594) or E3AS Series Catalog for the food and commodity industry (No. E595).

Note:1. Please contact your OMRON sales representative regarding the IO-Link setup file (IODD file).

Overview of IO-Link Compliant Devices

IO-Link Sensors

E3AS-F models

Metal case type

 Infrared light

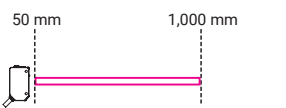
Connection method	Sensing distance (white paper)	IO-Link baud rate	Model
Pre-wired (2 m/ 5 m) M12 Pre-wired Smartclick Connector (0.3 m) M8 Connector (4-pin)	50 mm 1,500 mm 	COM2 (38.4kbps) COM3 (230.4kbps)	E3AS-F1500IM□(-□) □
	50 mm 1,000 mm 		E3AS-F1000IM□(-□) □

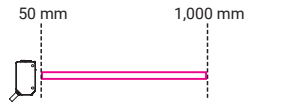

Plastic case type

 Infrared light

Connection method	Sensing distance (white paper)	IO-Link baud rate	Model
Pre-wired (2 m/ 5 m) M12 Pre-wired Smartclick Connector (0.3 m) M8 Connector (4-pin)	50 mm 1,500 mm 	COM2 (38.4kbps) COM3 (230.4kbps)	E3AS-F1500IP□(-□) □
	50 mm 1,000 mm 		E3AS-F1000IP□(-□) □

E3AS-L models

 Red light

Connection method	Sensing distance (white paper)	IO-Link baud rate	Model
Pre-wired (2 m/ 5 m) M12 Pre-wired Smartclick Connector (0.3 m) M8 Connector (4-pin)	10 mm 200 mm 	COM2 (38.4kbps) COM3 (230.4kbps)	E3AS-L200M□(-□) □
	10 mm 80 mm 		E3AS-L80M□(-□) □

For details, refer to E3AS Series Catalog for the automotive industry (No. E594) or E3AS Series Catalog for the food and commodity industry (No. E595).

Photoelectric Sensor

E3Z-□-IL□

IO-Link Makes Sensor Level Information Visible and Solves the Three Major Issues at Manufacturing Sites! Standard Photoelectric Sensor.



- Downtime can be reduced.
Notifies you of faulty parts and such phenomena in the Sensor in real time.
- The frequency of sudden failure can be decreased.
The light incident level monitor prevents false detection before it happens.
- The efficiency of changeover can be improved.
The batch check for individual sensor IDs significantly decreases commissioning time.
- Three types of sensing methods and three types of connection methods are available.



Red light Infrared light

Sensing method	Appearance	Connection method	Sensing distance	IO-Link baud rate	Model
Through-beam (Emitter + Receiver)		Pre-wired (2 m) M12 Pre-wired Smartclick Connector (0.3 m) M8 Connector (4-pin)	15m	COM2 (38.4kbps) COM3 (230.4kbps)	E3Z-T8□(-□)-IL□ □
Retro-reflective with MSR function		Pre-wired (2 m) M12 Pre-wired Smartclick Connector (0.3 m) M8 Connector (4-pin)	4m		E3Z-R8□(-□)-IL□ □
Diffuse-reflective		Pre-wired (2 m) M12 Pre-wired Smartclick Connector (0.3 m) M8 Connector (4-pin)	1m		E3Z-D8□(-□)-IL□ □
		Pre-wired (2 m) M12 Pre-wired Smartclick Connector (0.3 m) M8 Connector (4-pin)	90mm (narrow beam)		E3Z-L8□(-□)-IL□ □

*2. The Reflector is sold separately. Select the Reflector model most suited to the application.

For details, refer to E3Z-□-IL□ Data sheet.

Color Mark Photoelectric Sensor

E3S-DCP21-IL□

Color Mark Detection on Any Type of Packaging.
Narrow Beam and Large Lens for Stable
Detection of Workpieces Tilted at Various Angles.



- Detects subtle color differences.
High luminance, three-element (RGB) LED light source for greater light intensity. Highly efficient optics technology provides high power and enables stable detection even of subtle color differences.
- Handles glossy workpieces.
Thorough noise reduction.
High dynamic range covers everything from black to mirror surfaces.



Red light, Green light, Blue light

Sensing method	Appearance	Connection method	Sensing distance	Output	IO-Link baud rate	Model
Diffuse-reflective (mark detection)		M12 connector	10±3mm	Push-pull	COM2 (38.4kbps) COM3 (230.4kbps)	E3S-DCP21-IL□

For details, refer to E3S-DC/E3NX-CA Series Catalog (No. Y216).

Note:1. Please contact your OMRON sales representative regarding the IO-Link setup file (IODD file).

Overview of IO-Link Compliant Devices

IO-Link Sensors

Proximity Sensor

E2E/E2EQ NEXT Series

Enables easier and standardized designs previously not possible



- The world's longest sensing distance*¹
Nearly double the sensing distance of previous.
- With high-brightness LED, the indicator is visible anywhere from 360°.
- Only 10 Seconds*² to Replace a Proximity Sensor with the "e-jig"
(Mounting Sleeve).
- Cables with enhanced oil resistance enabled 2-year oil resistance*³.
- IP69K compliant for water resistance and wash resistance*⁴.
- Comes in a wide variation to make sensor selection easy.
- UL certification (UL60947-5-2)*⁵ and CSA certification
(CSA C22.2 UL60947-5-2-14).



*1. Based on December 2018 OMRON investigation.
 *2. Time required to adjust the distance when installing a Sensor. Based on OMRON investigation.
 *3. Refer to *Ratings and Specifications* of E2E/E2EQ Series Catalog (No. D121) for details.
 However, E2E Connector Models and E2EQ series is excluded.
 *4. E2EQ series is excluded.
 *5. M8 (4-pin) Connector Models are not UL certified.

PREMIUM Model E2E NEXT Series (Quadruple distance model)

Shielded

Size (Sensing distance)	Connection method	IO-Link baud rate	Model
M8 (4mm)	Pre-wired (2 m/ 5 m) M12 Pre-wired Smartclick Connector (0.3 m) M12 Connector M8 Connector (3-pin/ 4-pin)	COM2 (38.4kbps) COM3 (230.4kbps)	E2E-X4B□8(-□) □
M12 (9mm)	Pre-wired (2 m/ 5 m) M12 Pre-wired Smartclick Connector (0.3 m) M12 Connector		E2E-X9B□12(-□) □
M18 (14mm)			E2E-X14B□18(-□) □
M30 (23mm)			E2E-X23B□30(-□) □

For details, refer to E2E/E2EQ Series Catalog (No. D121).

PREMIUM Model E2E NEXT Series (Quadruple distance model)

Unshielded

Size (Sensing distance)	Connection method	IO-Link baud rate	Model
M8 (8mm)	Pre-wired (2 m/ 5 m) M12 Pre-wired Smartclick Connector (0.3 m) M12 Connector M8 Connector (3-pin/ 4-pin)	COM2 (38.4kbps) COM3 (230.4kbps)	E2E-X8MB□8(-□) □
M12 (16mm)	Pre-wired (2 m/ 5 m) M12 Pre-wired Smartclick Connector (0.3 m) M12 Connector		E2E-X16MB□12(-□) □
M18 (30mm)			E2E-X30MB□18(-□) □
M30 (50mm)			E2E-X50MB□30(-□) □

PREMIUM Model E2E NEXT Series (Triple distance model)

Shielded

Size (Sensing distance)	Connection method	IO-Link baud rate	Model
M8 (3mm)	Pre-wired (2 m/ 5 m) M12 Pre-wired Smartclick Connector (0.3 m) M12 Connector M8 Connector (3-pin/ 4-pin)	COM2 (38.4kbps) COM3 (230.4kbps)	E2E-X3B□8(-□) □
M12 (6mm)	Pre-wired (2 m/ 5 m) M12 Pre-wired Smartclick Connector (0.3 m) M12 Connector		E2E-X6B□12(-□) □
M18 (12mm)			E2E-X12B□18(-□) □
M30 (22mm)			E2E-X22B□30(-□) □

For details, refer to E2E/E2EQ Series Catalog (No. D121).

Note:1. Please contact your OMRON sales representative regarding the IO-Link setup file (IODD file).

Overview of IO-Link Compliant Devices

IO-Link Sensors

PREMIUM Model E2E NEXT Series (Triple distance model)

Unshielded

Size (Sensing distance)	Connection method	IO-Link baud rate	Model
M8 (6mm)	Pre-wired (2 m/ 5 m) M12 Pre-wired Smartclick Connector (0.3 m) M12 Connector M8 Connector (3-pin/ 4-pin)	COM2 (38.4kbps) COM3 (230.4kbps)	E2E-X6MB□8(-□) □
M12 (10mm)			E2E-X10MB□12(-□) □
M18 (20mm)			E2E-X20MB□18(-□) □
M30 (40mm)			E2E-X40MB□30(-□) □

BASIC Model E2E NEXT Series (Double distance model)

Shielded

Size (Sensing distance)	Connection method	IO-Link baud rate	Model
M8 (2mm)	Pre-wired (2 m/ 5 m) M12 Pre-wired Smartclick Connector (0.3 m) M12 Connector M8 Connector (3-pin/ 4-pin)	COM2 (38.4kbps) COM3 (230.4kbps)	E2E-X2B□8(-□) □
M12 (4mm)			E2E-X4B□12(-□) □
M18 (8mm)			E2E-X8B□18(-□) □
M30 (15mm)			E2E-X15B□30(-□) □

For details, refer to E2E/E2EQ Series Catalog (No. D121).

BASIC Model E2E NEXT Series (Double distance model)

Unshielded

Size (Sensing distance)	Connection method	IO-Link baud rate	Model
M8 (4mm)	Pre-wired (2 m/ 5 m) M12 Pre-wired Smartclick Connector (0.3 m) M12 Connector M8 Connector (3-pin/ 4-pin)	COM2 (38.4kbps) COM3 (230.4kbps)	E2E-X4MB□8(-□) □
M12 (8mm)	Pre-wired (2 m/ 5 m) M12 Pre-wired Smartclick Connector (0.3 m) M12 Connector		E2E-X8MB□12(-□) □
M18 (16mm)			E2E-X16MB□18(-□) □
M30 (30mm)			E2E-X30MB□30(-□) □

BASIC Model E2E NEXT Series (Single distance model)

Shielded

Size (Sensing distance)	Connection method	IO-Link baud rate	Model
M8 (1.5mm)	Pre-wired (2 m/ 5 m) M12 Pre-wired Smartclick Connector (0.3 m) M12 Connector M8 Connector (3-pin/ 4-pin)	COM2 (38.4kbps) COM3 (230.4kbps)	E2E-X1R5B□8(-□) □
M12 (2mm)	Pre-wired (2 m/ 5 m) M12 Pre-wired Smartclick Connector (0.3 m) M12 Connector		E2E-X2B□12(-□) □
M18 (5mm)			E2E-X5B□18(-□) □
M30 (10mm)			E2E-X10B□30(-□) □

For details, refer to E2E/E2EQ Series Catalog (No. D121).

Note:1. Please contact your OMRON sales representative regarding the IO-Link setup file (IODD file).

Overview of IO-Link Compliant Devices

IO-Link Sensors

BASIC Model E2E NEXT Series (Single distance model)

Unshielded

Size (Sensing distance)	Connection method	IO-Link baud rate	Model
M8 (2mm)	Pre-wired (2 m/ 5 m) M12 Pre-wired Smartclick Connector (0.3 m) M12 Connector M8 Connector (3-pin/ 4-pin)	COM2 (38.4kbps) COM3 (230.4kbps)	E2E-X2MB□8(-□) □
M12 (5mm)			E2E-X5MB□12(-□) □
M18 (10mm)			E2E-X10MB□18(-□) □
M30 (18mm)			E2E-X18MB□30(-□) □

PREMIUM Model E2EQ NEXT Series (Spatter-resistant Triple distance model)

Shielded

Size (Sensing distance)	Connection method	IO-Link baud rate	Model
M8 (3mm)	Pre-wired (2 m/ 5 m) M12 Pre-wired Smartclick Connector (0.3 m) M12 Connector	COM2 (38.4kbps) COM3 (230.4kbps)	E2EQ-X3B□8(-□) □
M12 (6mm)			E2EQ-X6B□12(-□) □
M18 (12mm)			E2EQ-X12B□18(-□) □
M30 (22mm)			E2EQ-X22B□30(-□) □

For details, refer to E2E/E2EQ Series Catalog (No. D121).

BASIC Model E2EQ NEXT Series (Spatter-resistant Double distance model)

Shielded

Size (Sensing distance)	Connection method	IO-Link baud rate	Model
M8 (2mm)	Pre-wired (2 m/ 5 m) M12 Pre-wired Smartclick Connector (0.3 m) M12 Connector	COM2 (38.4kbps) COM3 (230.4kbps)	E2EQ-X2B□8(-□) □
M12 (4mm)			E2EQ-X4B□12(-□) □
M18 (8mm)			E2EQ-X8B□18(-□) □
M30 (15mm)			E2EQ-X15B□30(-□) □

BASIC Model E2EQ NEXT Series (Spatter-resistant Single distance model)

Shielded

Size (Sensing distance)	Connection method	IO-Link baud rate	Model
M8 (1.5mm)	Pre-wired (2 m/ 5 m) M12 Pre-wired Smartclick Connector (0.3 m) M12 Connector	COM2 (38.4kbps) COM3 (230.4kbps)	E2EQ-X1R5B□8(-□) □
M12 (2mm)			E2EQ-X2B□12(-□) □
M18 (5mm)			E2EQ-X5B□18(-□) □
M30 (10mm)			E2EQ-X10B□30(-□) □

For details, refer to E2E/E2EQ Series Catalog (No. D121).

Note:1. Please contact your OMRON sales representative regarding the IO-Link setup file (IODD file).

Overview of IO-Link Compliant Devices

IO-Link Sensors

Welding Proximity Sensor

E2EW Series DC 3-wire

Stable detection in lines containing both aluminum and iron



- Equivalent sensing distances for both iron and aluminum *1.
- Enables common design for lines with both iron and aluminum *1.
- The exceptional sensing range *2, which means fewer false detections and thereby fewer unexpected stoppages.
- OMRON's unique fluororesin coating technologies enable longlasting spatter resistance *4, eliminates the need to replace for 10 years *3.
- Durable full metal body to reduce unexpected stoppages.
- Laser printed information (sensing distance on the sensor head, model on the cable, and model on the metal part of the connector model) can be reducing errors during sensor replacement. *5
- Equipped with a function, which effectively cancels pulse noise of current magnetic field. *1
- UL certification (UL60947-5-2) and CSA certification (CSA C22.2 UL60947-5-2-14).



*1. PREMIUM Models only.

*2. Based on November 2020 OMRON investigation.

*3. This value assumes that the sensor operates 10 hours a day in an arc welding environment and is cleaned once a month (12 times a year).

If our previous model (E2EF-Q) needs to be replaced once every 3 times it is cleaned, the E2EW-Q Proximity Sensor needs to be replaced once every 180 times it is cleaned. This means that there is no need to replace the E2EW-Q Proximity Sensor for 10 or more years.

*4. Models with spatter-resistant coating only.

*5. Models without spatter-resistant coating only.

PREMIUM Model E2EW Series (Quadruple distance model)

Shielded

Size (Sensing distance)	Connection method	IO-Link baud rate	Model
M12 (7mm)	Pre-wired (2 m/ 5 m) M12 Pre-wired Smartclick Connector (0.3 m) M12 Connector	COM2 (38.4kbps) COM3 (230.4kbps)	E2EW-X7B□12(-□) □
M18 (12mm)			E2EW-X12B□18(-□) □
M30 (22mm)			E2EW-X22B□30(-□) □

PREMIUM Model E2EW Series (Triple distance model)

Shielded

Size (Sensing distance)	Connection method	IO-Link baud rate	Model
M12 (6mm)	Pre-wired (2 m/ 5 m) M12 Pre-wired Smartclick Connector (0.3 m) M12 Connector	COM2 (38.4kbps) COM3 (230.4kbps)	E2EW-X6B□12(-□) □
M18 (10mm)			E2EW-X10B□18(-□) □
M30 (20mm)			E2EW-X20B□30(-□) □

For details, refer to E2EW Series Catalog (No. D122).

PREMIUM Model E2EW-Q Series (Spatter-resistant Quadruple distance model)

Shielded

Size (Sensing distance)	Connection method	IO-Link baud rate	Model
M12 (7mm)	Pre-wired (2 m/ 5 m) M12 Pre-wired Smartclick Connector (0.3 m) M12 Connector	COM2 (38.4kbps) COM3 (230.4kbps)	E2EW-QX7B□12(-□) □
M18 (12mm)			E2EW-QX12B□18(-□) □
M30 (22mm)			E2EW-QX22B□30(-□) □

PREMIUM Model E2EW-Q Series (Spatter-resistant Triple distance model)

Shielded

Size (Sensing distance)	Connection method	IO-Link baud rate	Model
M12 (6mm)	Pre-wired (2 m/ 5 m) M12 Pre-wired Smartclick Connector (0.3 m) M12 Connector	COM2 (38.4kbps) COM3 (230.4kbps)	E2EW-QX6B□12(-□) □
M18 (10mm)			E2EW-QX10B□18(-□) □
M30 (20mm)			E2EW-QX20B□30(-□) □

For details, refer to E2EW Series Catalog (No. D122).

EV Battery Manufacturing Proximity Sensor

E2EW-EV Series

Copper- and zinc-free ^{*1} EV battery manufacturing proximity sensor



- Equivalent sensing distances for both iron and aluminum.
- Enables common design for lines with both iron and aluminum.
- The exceptional sensing range, which means fewer false detections and thereby fewer unexpected stoppages.
- Durable full metal body to reduce unexpected stoppages.
- Laser printed information (sensing distance on the sensor head and model on the cable) can be reducing errors during sensor replacement.
- UL certification (UL60947-5-2) and CSA certification (CSA C22.2 UL60947-5-2-14).



*1. Metals used for a housing contain 5% or less of specific substances. (Based on our investigation.)

PREMIUM Model (Triple distance model)

Shielded

Size (Sensing distance)	Connection method	IO-Link baud rate	Model
M12 (6mm)	Pre-wired (2 m) M12 Pre-wired Smartclick Connector (0.3 m)	COM2 (38.4kbps) COM3 (230.4kbps)	E2EW-X6B□12(-□) -EV□
M18 (10mm)			E2EW-X10B□18(-□) -EV□

For details, refer to E2EW-EV Series Datasheet (No. D127).

Note:1. Please contact your OMRON sales representative regarding the IO-Link setup file (IODD file).

Overview of IO-Link Compliant Devices

IO-Link Sensors

Safety Light Curtain / Safety Multi-Light Beam

F3SG-SR/PG



Easy to monitor and ready for IoT

- Conforms to major international standards.
- Environmental resistance and rugged structure for use in any environment (IP67, IP67G *1).
- A broad line-up, from finger protection to body protection.
- Flexible height model for easy integration into machines and lines.
- For diverse applications, from simple protection to data utilization.



*1. IEC 60529/JIS C 0920 Annex 1

Safety Light Curtain F3SG-SR

Finger protection (Detection capability: 14-mm dia.)

Number of beams	Protective height (mm)	Advanced Model	Standard Model
15 to 199	160 to 2,000	F3SG-4SRA□□□□-14(-F)	F3SG-4SRB□□□□-14(-F)

Hand protection (Detection capability: 25-mm dia.)

Number of beams	Protective height (mm)	Advanced Model	Standard Model
8 to 124	160 to 2,480	F3SG-4SRA□□□□-25(-F)	F3SG-4SRB□□□□-25(-F)

Arm/Leg protection (Detection capability: 45-mm dia.)

Number of beams	Protective height (mm)	Advanced Model	Standard Model
6 to 38	240 to 1,520	F3SG-4SRA□□□□-45	F3SG-4SRB□□□□-45

Body (Detection capability: 85-mm dia.)

Number of beams	Protective height (mm)	Advanced Model	Standard Model
4 to 12	280 to 920	F3SG-4SRA□□□□-85	F3SG-4SRB□□□□-85

Note:1. Mounting brackets are not included. Order brackets sold separately.

Note:2. Connection cables are not included with the safety light curtain. Order cables sold separately.

For details, refer to F3SG-SR/PG Series Catalog (No. F105).

Safety Multi-Light Beam F3SG-PG

Perimeter access guarding (Beam gap: 300 to 500 mm)

Number of beams	Product length (mm)	Advanced Model
2, 3 and 4	670 to 1,370	F3SG-4PGA□□□□-□A

Perimeter guarding long range (Beam gap: 300 to 500 mm)

Number of beams	Product length (mm)	Advanced Model
2, 3 and 4	670 to 1,370	F3SG-4PGA□□□□-□L

Perimeter guarding passive mirror (Beam gap: 300 to 500 mm)

Number of beams	Product length (mm)	Advanced Model
2, 3 and 4	670 to 1,370	F3SG-4PGA□□□□-2C/4C

Note:1. Mounting brackets are not included. Order brackets sold separately.

Note:2. Connection cables are not included with the safety multi-light beam. Order cables sold separately.

Intelligent Tap

Used to configure the F3SG-SR/PG and connect external devices via IO-Link.

Appearance	Type	Model
	Intelligent Tap	F39-SGIT-IL3

Note:1. The cable to connect between the intelligent tap and IO-Link master unit is available.

For details, refer to F3SG-SR/PG Series Catalog (No. F105).

Note:1. Please contact your OMRON sales representative regarding the IO-Link setup file (IODD file).

Overview of IO-Link Compliant Devices

IO-Link Master Unit

IP67 Remote Terminal NXR-series IO-Link Master Unit

NXR-ILM08C-EIT/NXR-ILM08C-ECT

Streamline commissioning and maintenance of production equipment Simple, easy, and quick-Reduce Availability Loss and Quality Loss!



- Replacement without software by I/O port quick settings.
- Visualization of communication quality.
Counts IO-Link and Ethernet communication errors.
- LED indicator: Superior visibility by color universal design.

Name	Number of IO-Link ports	Degree of protection	Port connection	Model
EtherNet/IP IO-Link Master Unit	8	IP67	M12 connector (A-coding female)	NXR-ILM08C-EIT
EtherCAT IO-Link Master Unit				NXR-ILM08C-ECT NEW

For details, refer to NXR Series Catalog (No. R202).

IO-Link I/O Hub

IP67 Remote Terminal NXR-series IO-Link I/O Hub

NXR-□D166C-IL2

Reduced wiring system with IO-Link

- Simple wiring via IO-Link master.
- Condition monitoring of machines.
Detects disconnections and short circuits in I/O cables.
Measures voltage of power supplied to units.
- LED indicator: Superior visibility by color universal design.



Name	Number of I/O ports	Number of inputs/outputs	Degree of protection	Port connection	Model
IO-Link I/O Hub	8	16 digital inputs	IP67	M12 connector (A-coding female)	NXR-ID166C-IL2
		16 digital inputs/outputs			NXR-CD166C-IL2

For details, refer to NXR Series Catalog (No. R202).

IO-Link Master Unit

NX-series IO-Link Master Unit

NX-ILM400

IO-Link makes sensor level information visible and solves the three major issues at manufacturing sites!
The screwless clamping terminal block reduces wiring work.

EtherNet/IP
EtherCAT



- Downtime can be reduced. Notifies you of faulty parts and such phenomena in the Sensor in real time.
- The frequency of sudden failure can be decreased.
Condition monitoring of sensors and equipment to prevent troubles.
- The efficiency of changeover can be improved.
The batch check for individual sensor IDs significantly decreases commissioning time.

Product Name	Number of IO-Link ports	I/O refreshing method	I/O connection terminals	Model
NX-series IO-Link Master Unit	4	Free-Run refreshing	Screwless clamping terminal block	NX-ILM400

For details, refer to NX-ILM400 Data sheet.

GX-series IO-Link Master Unit

GX-ILM08C

IO-Link makes sensor level information visible and solves the three major issues at manufacturing sites!
The unit for M12 Smartclick connector can be used in watery, and dusty environments.

EtherCAT



- Downtime can be reduced. Notifies you of faulty parts and such phenomena in the Sensor in real time.
- The frequency of sudden failure can be decreased.
Condition monitoring of sensors and equipment to prevent troubles.
- The efficiency of changeover can be improved.
The batch check for individual sensor IDs significantly decreases commissioning time.

Product Name	Number of IO-Link ports	Environmental resistance	I/O connection terminals	Model
GX-series IO-Link Master Unit	8	IP67	M12 connector (A-coding female)	GX-ILM08C

For details, refer to GX Series Data sheet.

Software

Product Name	Model
Sysmac Studio *1	SYSMAC-SE2□□□

*1. CX-ConfiguratorFDT for IO-Link sensor setup is included in Sysmac Studio.

For details, refer to Sysmac Studio Ver.1.□□□ Data sheet.

Note:1. Please contact your OMRON sales representative regarding the IO-Link setup file (IODD file).

EtherCAT® is a registered trademark and patented technology, licensed by Beckhoff Automation GmbH, Germany.
EtherNet/IP™ is a trademark of ODVA.
USB Type-C™ is a trademark of USB Implementers Forum.
Smartclick is a registered trademark of OMRON Corporation.
Other company names and product names in this document are the trademarks or registered trademarks of their respective companies.
The product photographs and figures that are used in this catalog may vary somewhat from the actual products.

Note: Do not use this document to operate the Unit.

OMRON Corporation Industrial Automation Company

Kyoto, JAPAN

Contact : www.ia.omron.com

Regional Headquarters

OMRON EUROPE B.V.

Wegalaan 67-69, 2132 JD Hoofddorp
The Netherlands
Tel: (31) 2356-81-300 Fax: (31) 2356-81-388

OMRON ELECTRONICS LLC

2895 Greenspoint Parkway, Suite 200
Hoffman Estates, IL 60169 U.S.A.
Tel: (1) 847-843-7900 Fax: (1) 847-843-7787

OMRON ASIA PACIFIC PTE. LTD.

438B Alexandra Road, #08-01/02 Alexandra
Technopark, Singapore 119968
Tel: (65) 6835-3011 Fax: (65) 6835-3011

OMRON (CHINA) CO., LTD.

Room 2211, Bank of China Tower,
200 Yin Cheng Zhong Road,
PuDong New Area, Shanghai, 200120, China
Tel: (86) 21-6023-0333 Fax: (86) 21-5037-2388

Authorized Distributor:

©OMRON Corporation 2016-2023 All Rights Reserved.
In the interest of product improvement,
specifications are subject to change without notice.

CSM_10_3

Cat. No. Y229-E1-08 1223 (0618)